

ANALYTICAL BALANCES AS 3Y

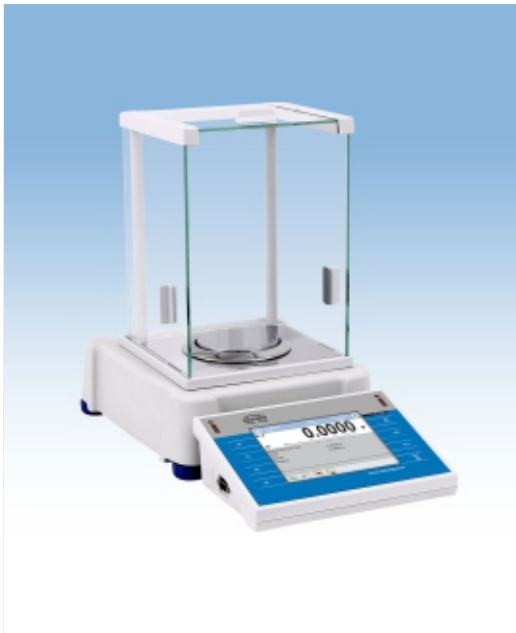

release date 31-10-2012















Balances AS 3Y series are laboratory weighing instruments featuring 5,7" LCD colour touch panel which provides new possibilities of balance operation and presenting measurement results.

Personalization of balance settings is carried out in extended user profiles. AS 3Y series comes standard with system of automatic adjustment using an internal mass standard. Level control is based on LevelSENSING system, RADWAG patented solution, which uses a system of an electronic level. New function of AS 3Y series is online monitoring of ambient conditions through built-in sensors or an external ambient conditions module THB 2 series.

AS 3Y series comes standard with esthetic weighing chamber protected by an anti-draft shield. Design of the weighing chamber enables easy disassembling of its glass parts, for keeping clean sterile.

Interactive formulation mode in the AS 3Y series is a reliable tool for creating various mixtures with application of databases. Differential weighing mode aids mass control of the same sample subjected to differed processes over time. Extended databases enable storing all carried out measurements, with option of printing and exporting them. Standard and user defined printouts allow for maintaining documentation complying with GLP/GMP requirements practically in any application. AS 3Y series features an independent mass control mode carried out with application of an automatic feeder PA-02/H.

-  Weighing
-  Parts counting
-  Checkweighing
-  Filling
-  Percent setup
-  Density determination
-  Animal weighing
-  Formulation
-  Statistics
-  Pipette calibration
-  Differential weighing
-  Mass control

✓ Removable glass parts: side, top and back!

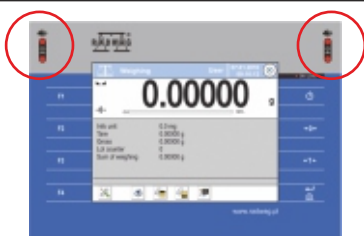
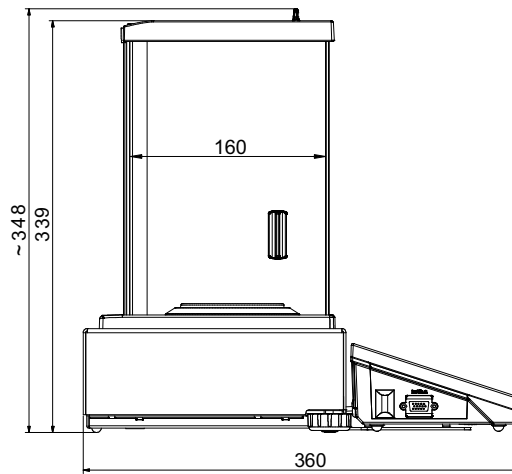
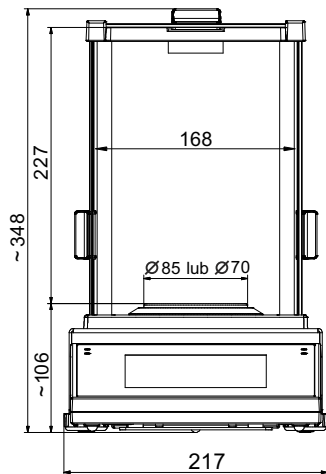

Infrared proximity sensors

- PRINT function
- TARE function
- sensors' sensitivity adjustment



Data exchange through USB storage devices

- export weighing data
- export/import databases
- export/import balance settings
- exchanging data between balances



Communication interfaces

- Ethernet 10/100Mbit
- RS 232
- 2×USB 2.0
- 4 in/out

Technical data:

	AS 110.3Y M	AS 160.3Y M	AS 220.3Y M	AS 310.3Y M	AS 510.3Y -
Max capacity	110 g	160 g	220 g	310 g	510 g
Minimal load	10 mg	10 mg	10 mg	10 mg	10 mg
Readability	0,1 mg	0,1 mg	0,1 mg	0,1 mg	0,1 mg
Tare range	-110 g	-160 g	-220 g	-310 g	-510 g
Working temperature *	+10° ÷ +40°C				
Relative air humidity ***	40% ÷ 80%				
Repeatability **	0,1 mg	0,1 mg	0,1 mg	0,1 mg (220g) 0,2 mg (220g+310g)	0,1 mg (220g) 0,2 mg (310g) 0,3 mg (510g)
Linearity	± 0,2 mg	± 0,2 mg	± 0,2 mg	± 0,3 mg	± 0,4 mg
Stabilization time	2 s	2 s	2 s	2 s	2 s
Sensitivity drift	1 ppm/°C in temperature +15° ÷ +35°C				
Interface	2×USB, RS 232, Ethernet, 4 Inputs / 4 Outputs (digital)				
Power supply	13,5 ÷ 16 V DC / 2,1 A				
Adjustment / Calibration	internal (automatic)				
Pan size	ø85 mm	ø85 mm	ø85 mm	ø85 mm	ø85 mm
Display	5,7" touch panel				

* The balance maintains its parameters in accordance with type approval in temperature 18°C ÷ 30°C

** Repeatability is expressed as a standard deviation from 10 weighing cycles (mass of 60g for balances with d=0,01mg and 220g for balances with d=0,1mg)

*** Non-condensing conditions

Additional equipment:

Antivibration table for laboratory balances	Additional LCD display "WD-5/3Y"
Professional weighing table	Density determination kit
Kafka thermal printer	PC USB keyboard
Dot matrix Epson printer	Automatic feeder PA-02/H
Label printer Citizen	Power adapter with battery and charger ZR-02
Holdings for glass vessels	Rack for under hook weighing
Tare and "Print" foot button	Standard mass
PW-WIN computer software	Antistatic cable PA 1
RAD-KEY computer software	Bar code scanner
Antistatic ionizer DJ-02	Cable RS 232 (scale - Kafka printer) "P0136"
THB 2 ambient conditions module	Cable RS 232 (scale, Epson , Citizen printer) "P0151"